

ATCO NEWSLETTER

VOLUME 5 NUMBER 1

JANUARY 1988

IT'S TIME TO RENEW YOUR ATCO MEMBERSHIP!

Unless you renew your ATCO membership, this is your last issue of the ATCO Newsletter.

You will find details concerning ATCO membership listed on page nine of the October 1987 newsletter.

HAPPY NEW YEAR!

Take a Look at ATCO in 1987.....	Page 2
One Transistor Video Modulator.....	Page 3
Arithmetickler - Win a Black and White TV Monitor.....	Page 4
ATCO ATV Station Maps.....	Pages 5 and 9
Antenna Stacking Formulas.....	Page 6
Vidicon Tube Basics.....	Page 7
Relating Noise Figure to Noise Temperature.....	Page 8
ATV News Items of Interest.....	Pages 9, 10, and 11
List of ATCO Members.....	Page 12
Financial Statement.....	Page 13

The ATCO Newsletter is the official publication of a group of television amateurs known as "AMATEUR TELEVISION IN CENTRAL OHIO" and is published in January, April, July, and October.

Membership in ATCO is open to any FCC licensed radio amateur who has an interest in amateur television.

Any reproduction of material printed in the ATCO Newsletter without the written consent of ATCO is prohibited.

TAKE A LOOK AT ATCO IN 1987

We believe 1987 was a good year for ATV, and a review of ATCO's activities would be of interest to you.

During an October 1986 ATCO Tuesday Night Net, the question arose as to what might be done to stimulate more interest in ATV in Columbus and the surrounding area. One suggestion was to resume publication of a newsletter. For this purpose, one volunteer stepped forward, and you are now reading the fifth consecutive ATCO Newsletter issued quarterly since January 1987.

Another suggestion was to reorganize ATCO on an informal basis (see ATCO Newsletter vol. 4, no. 1, page 2). Again, we found ATV hams willing to volunteer to assist in getting the word about ATCO to prospective members and to be Tuesday Night ATCO Net Managers.

At first, response to joining ATCO as a dues paying member was not too great - only a handful of ATV operators submitted applications and checks. About the middle of February, a few more ATVers joined making the total ten. Then more operators gave us their support; by the end of March, ATCO boasted a membership of 19. As April, May, and June went by, we picked up four additional members.

Plans for an Antenna Measuring Party were discussed along with the idea that such an event would give us the opportunity to socialize and enjoy our common interest. Almost immediately after publicizing the party, the membership list increased to 35. The 19 September ATCO get-together was a successful undertaking (see October 1987 issue of the ATCO Newsletter). As of 31 December 1987, ATCO had 43 members!

Many of our members were increasingly involved in both air and land mobile ATV activities. The WB8ELK balloon launch got our attention as did WBBURI's DX operation. WB8TMP gave us ATV participation on Field Day.

Several ATV stations installed vertically and horizontally polarized receiving and transmitting facilities. Additional ATVers began operating on 1270 MHz, and the Dayton ATV Repeater was improved.

Throughout the year, the ATCO Tuesday Night Net continued to provide us with an on the air meeting place, and the opportunity to share our ideas with each other.

Many informative technical articles were written by our members and were published in the ATCO Newsletter. At year's end, plans were underway for a technical meeting to be held in the early spring. Such a meeting should help us to increase our knowledge of amateur television.

ONE TRANSISTOR VIDEO MODULATOR

A schematic diagram for a one transistor video modulator for grid modulating small to medium power tubes for ATV is shown below. This circuit modulates the 5894 final in an RCA CMU 15 with good results.

The input video gain control should be adjusted so that the output power is about two-thirds of the maximum power when the final was unmodulated. (Submitted by Guy, KBHVA.)

[A four transistor video modulator employing negative feedback will be included in the April ATCO Newsletter. - Ed.]

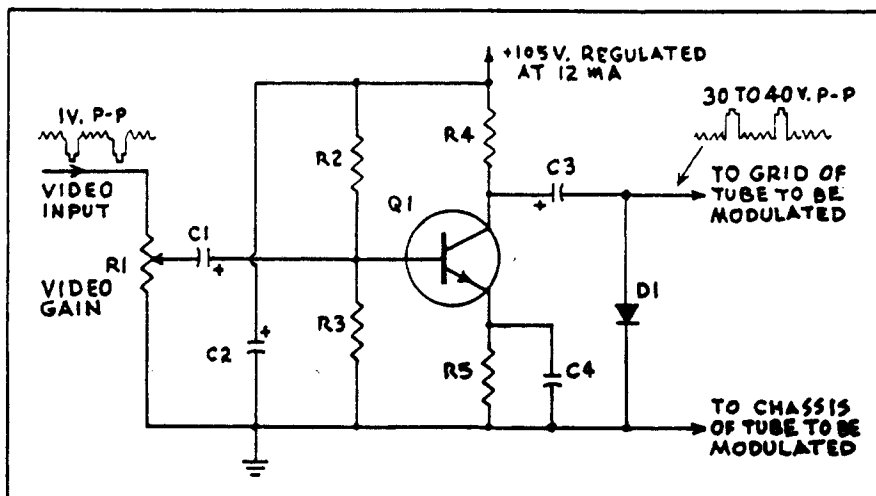

SCHMATIC FOR ONE TRANSISTOR VIDEO MODULATOR

- C1 - 100 uF, 25V dc, electrolytic
- C2,C3 - 8 uF, 150V dc, electrolytic
- C4 - 470 pF
- D1 - diode, 1N4001
- Q1 - transistor, 2N3440, 2N5058, or RS-276-2038. A heat sink should be added to insure a long usage life.
- R1 - 100 ohms, video gain
- R2 - 100 k ohms
- R3 - 1 k ohms
- R4 - 5.6 k ohms, 2 watts
- R5 - 47 ohms

REMINDER

Have you checked the expiration date on your ham license recently? If it is time to renew (approximately 90 days prior to expiration), then attach a photocopy of your license to a completed FCC Form 610 and mail to FCC, P.O. Box 1020, Gettysburg, PA 17326. Your license will be renewed for a period of ten years.

NEWS DEADLINE FOR APRIL ATCO NEWSLETTER IS 15 MARCH 1988!

NEW ATCO MEMBERS

Since the October issue of the ATCO Newsletter, eight new members have been added to our roster.

We welcome the following:

Dave, KB2ARL	Emmett, WABATF	Joe, WBBBW	George, WB8JDV
Bill, KN8DMK	Tom, WD8OBT	Jack, W8VSY	Bill, K88UU

JANUARY ARITHMETICKLER

Did you notice that the "Arithmeticker" has a new name? This month, you are getting a chance to win a solid state high resolution black and white 14 inch TV monitor - how about that? Thanks to Bill, W8FRQ, for donating the prize to ATCO. Contest rules are listed below.

For those who solved the ATCO Newsletter's October Arithmetickler "in their heads," this one may require a little more profound cogitation - good luck!

The combined ages of Bill's and Dave's ATV transmitters total 44 years. Bill's is twice as old as Dave's was when Bill's was half as old as Dave's will be when Dave's is three times as old as Bill's was when Bill's was three times as old as Dave's. How old is each transmitter?

CONTEST RULES: You must be listed on the 31 December 1987 ATCO Membership List to be eligible to enter. The earliest postmarked correct solution to the January Arithmetickler (above) mailed to the ATCO Newsletter Editor will be declared to be the winner of the TV monitor. In the event of a tie, Bill, W8FRQ, will conduct a drawing to determine the lucky ATVer. The contest winner must pick up his prize at W8FRQ's QTH.

OUR CONTRIBUTORS

Thanks to the following ATV hams for their contributions to this issue of the ATCO Newsletter.

Guy, KBHVA, a first time contributor, for his "Antenna Stacking Formulas" and the "One Transistor Video Modulator" article.

Bill, W8FRQ, for keeping our brains working with his "Arithmetickler."

Dave, KB2ARL, another first time contributor, for "Vidicon Tube Basics."

Bill, W8DMR, for "Relating Noise Figure to Noise Temperature" and several interesting ATV news items.

ATCO ATV STATION MAP

COLUMBUS AND FRANKLIN COUNTY STATIONS

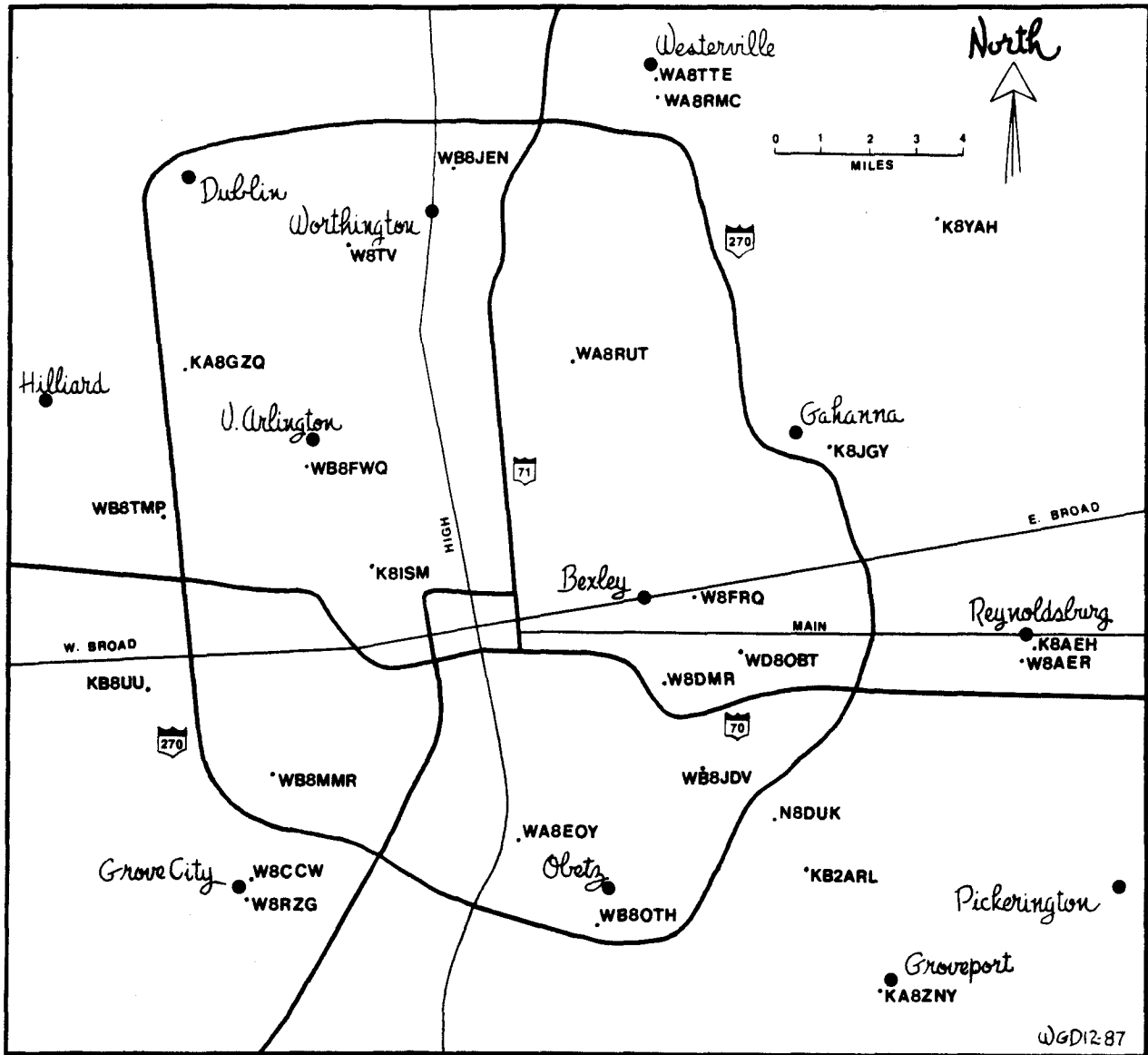

A WORD ABOUT THE STATION MAPS

The above ATCO ATV station map and the one on page nine of this issue of the ATCO Newsletter have been prepared to assist you in locating stations in the ATCO viewing area. Locations of stations in Columbus and Franklin County are considered to be reasonably accurate but not precise. Post office locations were used for stations outside of Franklin County.

It is suggested that you plot headings on these maps for future use in beaming your antenna.

**SOLUTION TO OCTOBER
ARITHMETICKLER**

Did you get \$50.50 as the cost of the wattmeter and \$24.50 for the ohmmeter? If not, here's how the problem can be solved:

Let x = cost of wattmeter Equation 1: x + y = \$75
 Let y = cost of ohmmeter Equation 2: x - \$26 = y

Substitute value of y in Equation 1 for y in Equation 2:

$$x - \$26 = \$75 - x$$

$$\begin{aligned} \text{Collecting terms: } 2x &= \$75 + \$26 \\ x &= (\$75 + \$26) / 2 \\ x &= \$50.50 \end{aligned}$$

$$\begin{aligned} \text{From Equation 2: } y &= x - \$26 \\ y &= \$50.50 - \$26 \\ y &= \$24.50 \end{aligned}$$

ANTENNA STACKING FORMULAS

Physical frontal antenna area is not the same as effective electrical area! To obtain stacking distance, first calculate the effective electrical area of the antennas to be stacked. Stack the antennas so that the adjacent sides of the apertures do not overlap. A formula for the effective aperture (Ae) is:

$$Ae = \frac{Gi \times (WL)^2}{4 \times \pi}$$

Where: Gi is the power gain of the antennas in reference to an isotropic radiator.
 WL is the wavelength for the frequency of operation.

If the antenna power gain is referenced to a dipole, use the formula below:

$$Ae = \frac{1.64 \times Gd \times (WL)^2}{4 \times \pi}$$

The above formulas are for antenna gains that are not in decibels. A dipole has 1.64 times the gain of an isotropic radiator which is also 2.14 dB. The effective aperture (Ae) will be in the same units of measure selected for wavelength (WL). (Submitted by Guy, KBHVA.)

 THE ATCO TUESDAY NIGHT NET MEETS EVERY WEEK AT 8 EST AND 9 EDT

VIDICON TUBE BASICS

Nearly all TV cameras use the vidicon tube and its variations. The vidicon consists of a flat glass window at one end, called the "target" of the tube, and an electron gun at the other end. Inside the window, a coating with a transparent conductive material is applied. Then a thin transparent photoconductive layer is placed over this coating. The photoconductive layer is electrically connected to a conductive metal ring on the outside of the envelope to which a stable positive voltage is applied. The main elements of the vidicon tube are shown in the drawing at the right.

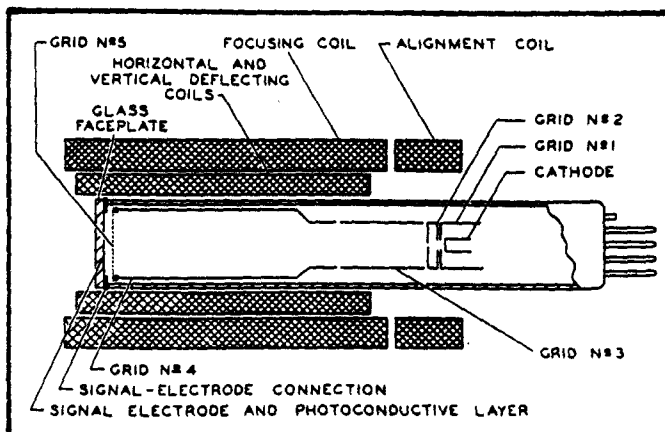

The conductivity of the target material is proportional to the amount of light falling on it. The gun side of the target is then scanned by a low velocity electron beam which provides an analog electrical version of the light image focused upon it. This output signal is capacitively coupled to the input of the video preamplifier. In most vidicons, the target coating material is an amorphous antimony trisulfide referred to as an N-type semiconductor.

Several important vidicon tube characteristics directly affect the quality of the TV picture. These are:

1. OUTPUT LEVEL AND NOISE. Obviously, a tube should have an output signal that is great enough to produce good quality video. If the output level is too low, noise will be introduced into the signal by the electronics when the signal is amplified.

2. DEFINITION OR RESOLUTION. The tube should be able to detect the fine detail of a scene. This is a function of both the tube and the accompanying circuitry.

3. FOCUS UNIFORMITY. The scene should be in focus over the entire phototarget. Although this can easily be obtained optically, the focusing of the beam as it scans the target is more difficult.

4. SHADING. This effect is caused by a higher signal level output from some parts of the target than from others. The result is some parts of the picture (usually at the edge of the target) appear as though they are in the shade.

5. LAG (IMAGE RETENTION). Lag occurs in all vidicons. When the camera is moved or an object moves in a scene, a "ghost" of the subject may remain in position on the screen and slowly fade away after several scans. If a camera remains in one position for a long period of time, the image may be permanently burned into the target. (continued on page 10)

RELATING NOISE FIGURE TO NOISE TEMPERATURE

Johnson noise, defined as a nonperiodic AC voltage fluctuation and in reality an effect of electron agitation, places a limit on the ultimate sensitivity of amplifiers, mixers, and preamplifiers. All high frequency transistors whether FET or bipolar devices, as well as all passive elements, reach a well-defined performance based on this effect.

Historically, transistors have been categorized by their noise figure (NF). The lower the noise figure, the better the device. But two decades ago within the confining technology of ultralow noise parametric amplifiers and hydrogen masers, another measure of performance was developed. This parameter, termed noise temperature, has established industry acceptance.

What does noise temperature really mean? Also how does one convert from noise figure specifications to noise temperature specifications to make comparisons?

At absolute zero, -273.18 deg. C., Brownian movement (hence electron agitation) ceases, and Johnson noise equals zero. Normal room temperature is generally regarded as 20 deg. C. Universal scientific consent has established the standard noise temperature at 290 deg. Kelvin (T_0). Active components such as transistors, however, can exhibit noise temperatures different from their operating or ambient temperatures. This exhibited noise temperature is termed the device's effective input noise temperature (T_e).

Another relevant term in understanding noise temperature, input available noise power (P), is calculated as $P = k T B$, where k is Boltzmann's constant ($k = 1.38 \times 10^{-23}$); B is bandwidth in hertz; and T is absolute temperature in degrees Kelvin.

The total noise output power (N_p) of an active transistor is, in effect, the sum of the input noise plus the noise contributed by the device. Thus: $N_p = G k B (T_{in} + T_e)$. G is device gain.

Because a device's noise figure is by definition the ratio of the total noise power to the input noise power, when the input termination is at the temperature of 290 degrees Kelvin, $NF = N_p / (G k B T_0)$.

Combining the two previous equations produces an expression for the relationship between noise figure and effective noise temperature: $NF = 1 + T_e/T_0$.

Finally, the noise figure is generally expressed in decibels so when expanded this expression yields $NF(\text{dB}) = 10 \log (1 + T_e/T_0)$.

Therefore: $T_e = 290 (\text{antilog} (NF/10) - 1)$ deg. Kelvin.

To put this expression into perspective, consider a GaAs FET preamp with a noise figure specification of 2.7 dB. What is its noise temperature? Answer: The effective noise temperature is, $T_e = 250$ deg. Kelvin. (Submitted by Bill, WBDMR.)

ATCO ATV STATION MAP

STATIONS LOCATED OUTSIDE OF FRANKLIN COUNTY

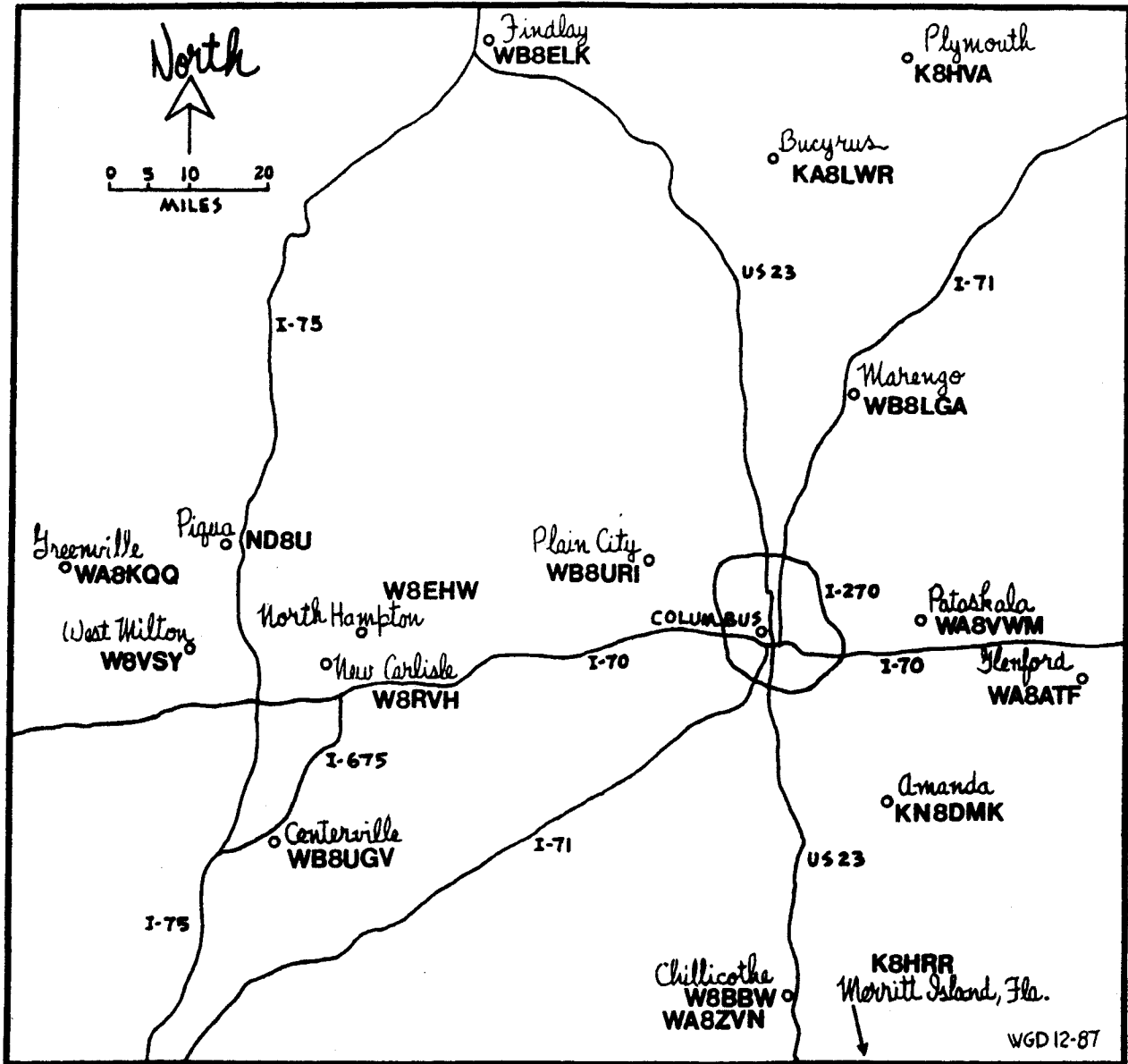

ATV NEWS ITEMS OF INTEREST

ATCO MEMBERS ATTEND AMSAT CONFERENCE - Bill, WB8ELK, Perry, WB8OTH, and Tom, K8BZNY, recently attended the AMSAT Conference in Detroit. They report fast scan ATV may be transmitted from the next space shuttle scheduled for 1988 or 1989. Tom made a video tape during one conference forum where AM versus FM ATV modulation was considered for the mission.

10-PIN CAMERA CONNECTOR - Another supplier of this connector has been found. Panasonic uses the part number VJS-25 which is the female chassis mount connector.

VIDICON TUBE BASICS

(continued from page 7)

Most of the five conditions listed on page seven can be controlled by the voltages applied to the grids. Generally, picture quality increases with higher voltages, and most cameras are designed to supply 250 volts or more. Also, as a vidicon tube ages, higher target voltages are required to produce an adequate output signal.

Typical vidicon circuitry is shown in the schematic drawing below. Surplus vidicon tubes can be found in flea markets at most hamfests and are therefore relatively inexpensive. (Submitted by Dave, KB2ARL.)

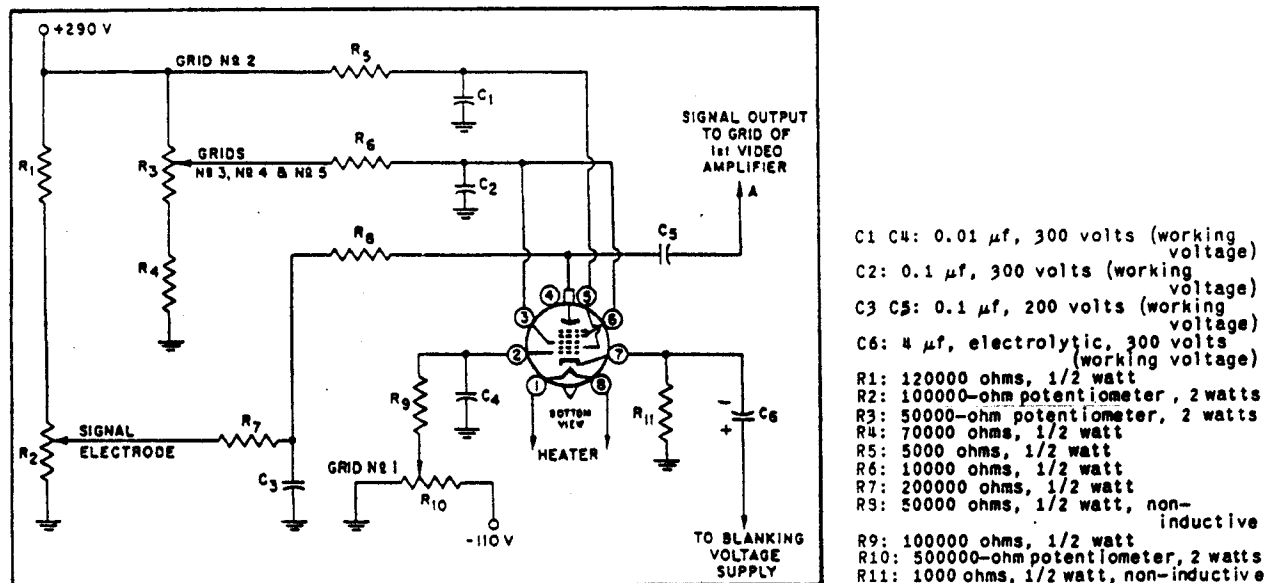

TYPICAL VIDICON CIRCUITRY

 RENEW YOUR ATCO MEMBERSHIP TODAY!

1.2 GHz ATV TESTING CONTINUES

During October, November, and December, the following ATV stations have been active on 1.2 GHz:

WBDMR	NBDUK	WBEHW	WABEOY	WABRUT
WBRVH	WABTTE	W88UGV	W88URI	K8YAH

Dick, WBRVH, has been conducting narrow band tests using his modified R-7000 receiver and has received signals from NBDUK, W88URI, and W88UGV. John, WABEOY, is now transmitting good color pictures with his modified APX-6 World War II surplus transmitter. The video modulator diagram for the APX-6 is shown in the October 1987 issue of the ATCO Newsletter.

ATV NEWS ITEMS OF INTEREST

By Bill, W8DMR

ATCO GETS NATIONWIDE ATTENTION - Spec-Com Magazine published several articles in their November 1987 issue which originally appeared on pages three, six, and seven of the January 1987 ATCO Newsletter. If you are a reader of Spec-Com Magazine, please note the reversed placement of the schematic diagram and the Line Sampler figure.

BALLOON LAUNCH FOLLOW-UP - WB8ELK's equipment has been found! A farmer found the transmitter and the associated electronic package in a bean field about 20 miles from Findlay. Bill (WB8ELK) has plans to conduct another launch early this year. The balloon launch demonstrated once again that there is no real substitute for antenna height.

THE ATV 10 WATT "BRICK" - Several ATCO members have requested information regarding the availability of thick-film linear UHF modules. The price of this component varies from \$59.00 to \$79.00 (plus shipping cost) and may be obtained from the following suppliers:

P.C. Electronics, 2522 S. Paxson Lane, Arcadia, CA 91006, phone (818) 447-4565 - Toshiba part no. S-AU4.

Richardson Electronics, 116 S. Long Beach Rd., Rockville, NY 11570, phone (800) 645-2322 - Motorola part no. MHW-710-2.

Note: The Toshiba S-AU4 unit lead connections are not the same as those for the Motorola MHW-710-2.

The Amperex module, part no. BGY41B, functions well, also. Does anyone know of a source for these units?

[Other ATV News Items of Interest will be found on pages nine and ten of this edition of the ATCO Newsletter. - Ed.]

APX-6 VIDEO MODULATOR CHANGES

The video modulator as described on page six of the October 1987 ATCO Newsletter does not possess sufficient high frequency response to modulate for good color and sound. Since the APX-6 exhibits attenuation of high frequency video at 1200 MHz, the high frequency response of the modulator must be greatly increased.

For quality video and color for the APX-6, the following circuit changes are required:

1. Remove 15 turns from L2 and shunt L2 with a 22 k ohms resistor (RS-271-038).
2. Add a .002 uF capacitor by-pass around R10 (two RS-272-126). (Submitted by John, WA8E0Y.)

ATCO MEMBERS AS OF 31 DEC 1987

KBAEH	Wilbur Wollerman 1672 Rosehill Road Reynoldsburg 43068	WB8LGA	Charles Beener 2548 State Route 61 Marengo 43334
WBAER	David Sears 1678 Kaiser Drive Reynoldsburg 43068	KABLWR	Marlin Alberty 1645 Olentangy Road Bucyrus 44820
KB2ARL	Dave DiGiuseppe 3841 Evanston Drive Columbus 43232	WB8MMR	Mike Knies 1715 Winding Hollow Dr. Columbus 43223
WABATF	Emmett McDonald 14120 Flintridge Rd. SE Glenford 43739	WD8OBT	Tom Camm 1267 Arkwood Avenue Columbus 43227
WBBBW	Joe Schumann 5418 Marietta Road Chillicothe 45601	WB8OTH	Perry Yantis 1850 Lisle Avenue Obetz 43207
WBCCW	John Ferrell 3722 Wagner Court Grove City 43123	WABRMC	Arthur Towslee 180 Fairdale Avenue Westerville 43081
KN8DMK	Bill Delker 8460 Bowers Road Amanda 43102	WABRUT	Ken Morris 3181 Gerbert Road Columbus 43224
WBDMR	William Parker 2738 Floribunda Drive Columbus 43209	WBRVH	Richard Goode 9391 Ballentine Road New Carlisle 45344
N8DUK	Ron Reynolds 4642 Glengate Drive Columbus 43232	WBRZG	Corwin Miller 4966 Haughn Road Grove City 43123
WBEHW	Foster Warren 124 East Clark Street North Hampton 45349	WB8TMP	Dave Bourne 2200 Dividend Drive Columbus 43228
WB8ELK	Bill Brown 12536 T.R. 77 Findlay 45840	WABTTE	Phil Morrison 154 Llewellyn Avenue Westerville 43081
WABEOY	John Schlaechter 3199 Lewis Road Columbus 43207	W8TV	Bob Dye 6118 Sedgwick Road Columbus 43085
WBFRQ	William Ennis 146 South Weyant Avenue Columbus 43213	N8BU	Philip Brooks 412 Franklin Street Piqua 45356
WB8FWQ	Christopher Vojsak 2050 Ellington Road Columbus 43221	WB8UGV	Bruce Jaquish 193 Cherry Drive Centerville 45459
KABGZQ	Warren Dummel 3488 Darbyshire Drive Hilliard 43026	WB8URI	William Heiden 4435 Kaufman Road Plain City 43064
K8HRR	Ira Bickham 260 Tiki Drive Merritt Is., FL 32952	K8BUU	William Rose 439 S. Murray Hill Road Columbus 43228
K8HVA	Guy Cunningham, Jr. 31 Birchfield Street Plymouth 44865	WBVSY	Jack Schmermund 401 North Main Street West Milton 45383
K8ISM	Steve Iacono 1075 Virginia Avenue Columbus 43212	WABVWM	Lou Williams 4720 Blacks Road SW Pataskala 43062
WB8JDV	George Martini 3027 Inn Road Columbus 43227	K8YAH	Ronald Vanke 5094 Longrifle Road Westerville 43081
WB8JEN	Bob Mills 6834 Halligan Avenue Worthington 43085	KABZNY	Tom Taft 386 Cherry Street Groveport 43125
K8JGY	Fred Yost 330 Dellfield Way Gahanna 43230	WABZVN	Willard Mathuews 221 Black Run Road Chillicothe 45601
WABKQQ	Dale Waymire 225 Riffle Avenue Greenville 45331		

ANNOUNCEMENT

Bill, WBDMR, has volunteered to be the Technical Editor of the ATCO Newsletter. His assistance in this capacity is greatly appreciated.

ATCO FINANCIAL STATEMENT

CASH BALANCE:
As of 30 September 1987.....\$173.87

RECEIPTS:
Dues.....\$160.00

EXPENDITURES:
Printing charges for October 1987 ATCO Newsletter....\$ 33.76
Postage for October 1987 ATCO Newsletter..... 13.26
Printing charges for reprints for new members..... 24.15
Postage for reprints sent to new members..... 5.62
25 postage stamps @.22 each..... 5.50
Misc. costs incidental to publication of newsletter.. 8.45

Total.....\$ 90.74

SUMMARY:
Cash Balance as of 30 September 1987.....\$173.87
Receipts..... 160.00
Expenditures..... - 90.74

Balance as of 31 December 1987.....\$243.13

22 CENT POSTAGE STAMP INVENTORY:
Stamps on hand as of 30 September 1987..... 10
Stamps purchased 12 November 1987..... 25
Stamps used..... -12

22 cent stamps on hand as of 31 December 1987..... 23

The above financial report was prepared as of 29 December 1987 by Warren G. Duemmel, K8BGZQ, Acting ATCO Treasurer.

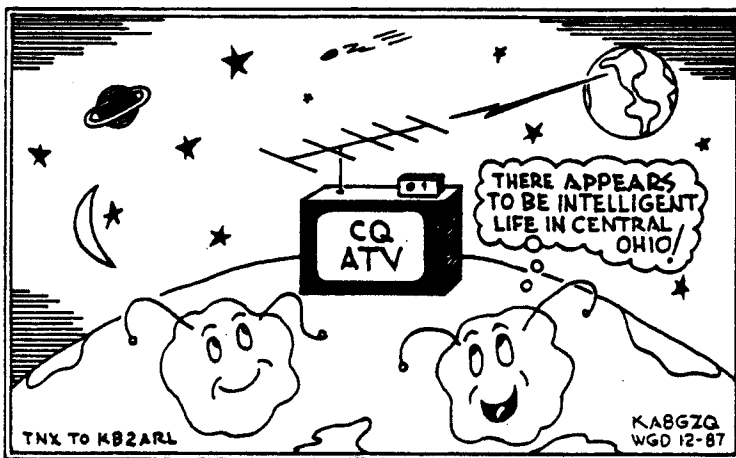

ATCO MEMBERSHIP APPLICATION

RENEWAL [] NEW MEMBER [] CHARTER MEMBER [] DATE.....
NAME.....CALL.....
ADDRESS.....HOME PHONE.....
CITY.....STATE.....ZIP.....
PLACE OF EMPLOYMENT.....BUS. PHONE.....
HAM INTERESTS.....LICENSE CLASS.....
I WILL TAKE ATCO NET-CONTROL TWICE A YEAR.....[YES].....[NO]
I WILL SUBMIT NEWSLETTER MATERIAL TWICE A YEAR.....[YES].....[NO]
ANNUAL DUES PAYMENT OF \$10 ENCLOSED.....CHECK [].....CASH []
..Make check payable to Warren G. Duemmel, Acting ATCO Treasurer.
..Mail to K8BGZQ, 3488 Darbyshire Drive, Hilliard, Ohio 43026...

Editor: Warren, K86Z0
Technical Editor: Bill, W8DWR

FIRST CLASS MAIL

ATCO NEWSLETTER
c/o Warren G. Duemmel
3488 Darbyshire Drive
Hilliard, Ohio 43026

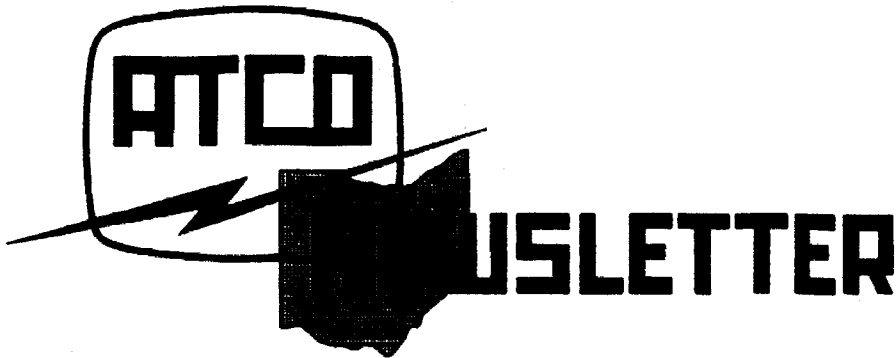

WIN A 14 INCH TV MONITOR!

SEE PAGE 4 FOR DETAILS